

eSight Go

User Manual

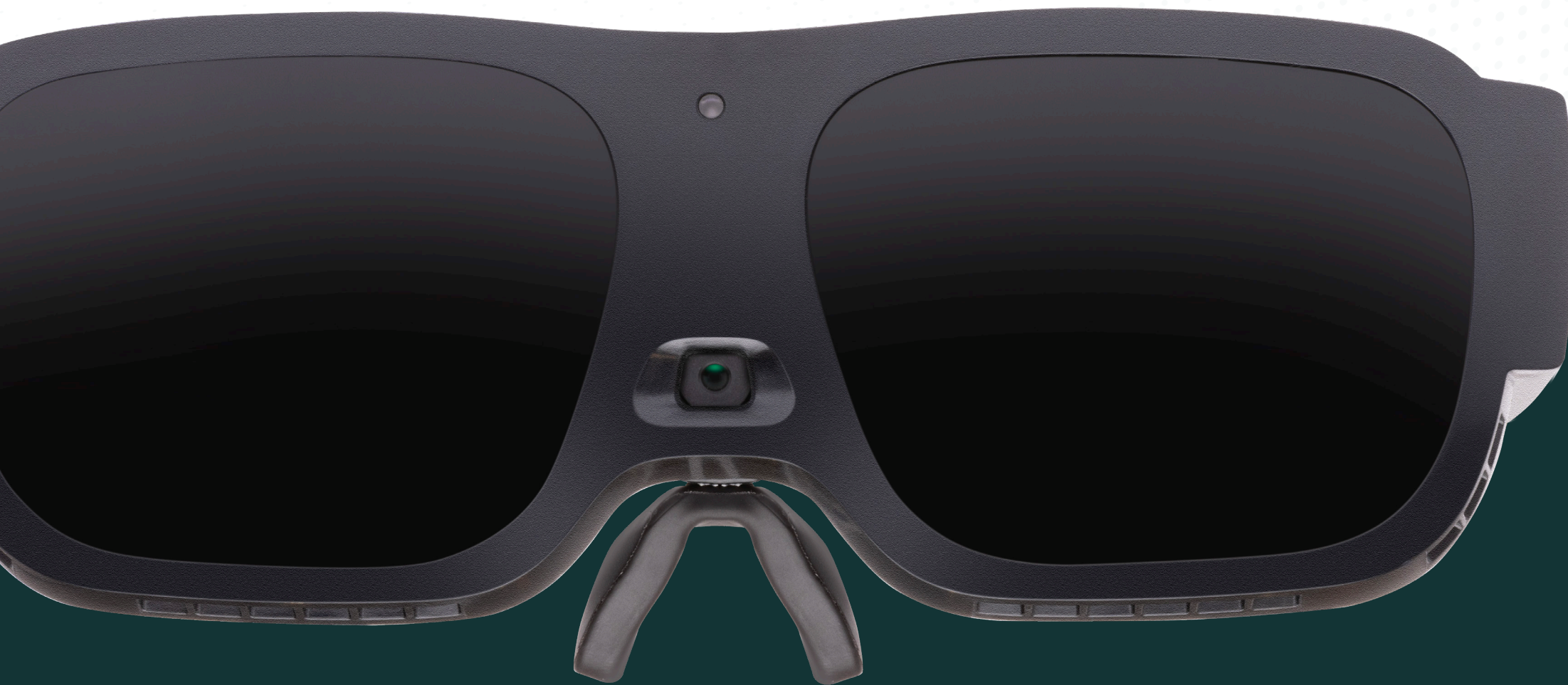

See new possibilities

eSight[®]
BY GENTEX CORPORATION

Safe Use and Care of eSight

Read the safety booklet before using eSight Go. It contains important warnings, regulatory compliance, care instructions, and safe usage information.

Copyright

© Copyright 2024, Gentex Corporation. All rights reserved.

May 2024

No part of this publication may be reproduced without the express written permission of Gentex Corporation.

“eSight Devices” and “eSight Go” by Gentex Corporation and associated images and symbols are trademarks of eSight Corporation. “eSight” is a registered trademark in Canada and the U.S. and may be pending or registered in other countries. Various U.S. and other patents pending. All other trademarks, registered trademarks, product names, and company names and/or logos cited herein, if any, are the property of their respective holders. eSight reserves the right to improve the contents of this User Manual without notice. eSight documentation is updated periodically for accuracy and completeness. Check esighteyewear.com/support for the latest version.

| | | | |
|--|----|-------------------------------|----|
| Welcome to eSight Go | 04 | Connecting the Remote | 20 |
| What's in the Box? | 05 | Remote Functions | 21 |
| Wearing eSight Go | 07 | Additional Information | 23 |
| Connecting Neck Battery Pack to Device | 08 | Connection and Controls | 24 |
| Positioning the Neck Battery Pack | 09 | Settings | 26 |
| Customizing the Fit | 10 | Features | 27 |
| Changing Nose Pieces | 11 | Device Cleaning and Care | 28 |
| Installing Prescription Lenses | 12 | Storing eSight Go | 29 |
| Powering eSight Go | 13 | Connecting eSight Go to Wi-Fi | 30 |
| Device Status Light | 15 | Technical Specifications | 31 |
| Charging the Neck Battery Pack | 16 | Customer Support and Warranty | 33 |
| Neck Battery Pack and Status Light | 17 | Troubleshooting | 34 |
| eSight Go Remote | 19 | Appendix | 35 |

eSight Go is a wearable digital vision enhancement device. It uses a high-resolution camera, OLED screens, and advanced image processing algorithms to capture the visual world and display enhanced video in real-time. eSight Go aims to improve performance of daily living activities and connect users to the world around them. It is not intended to completely restore vision or replace medical treatment. eSight Go makes no claims about the suitability of the device for any specific activity.



What's in the Box?

As you unpack your eSight Go device, make sure you have received all the items below:

- eSight Go device
- Neck battery pack with rechargeable battery
- 1.5-foot USB-C cable to connect device to neck battery pack
- Remote control with two AAA batteries
- AC power adapter with six-foot USB-C cable for charging
- Four adjustable nose pieces (one pre-installed)
- Microfiber cleaning cloth
- Neck lanyard
- Quick Start Guide
- Safety Guide
- Protective carrying case

Once you confirm you have received all eSight Go package contents, fully charge the device as described in "Charging your eSight Device."

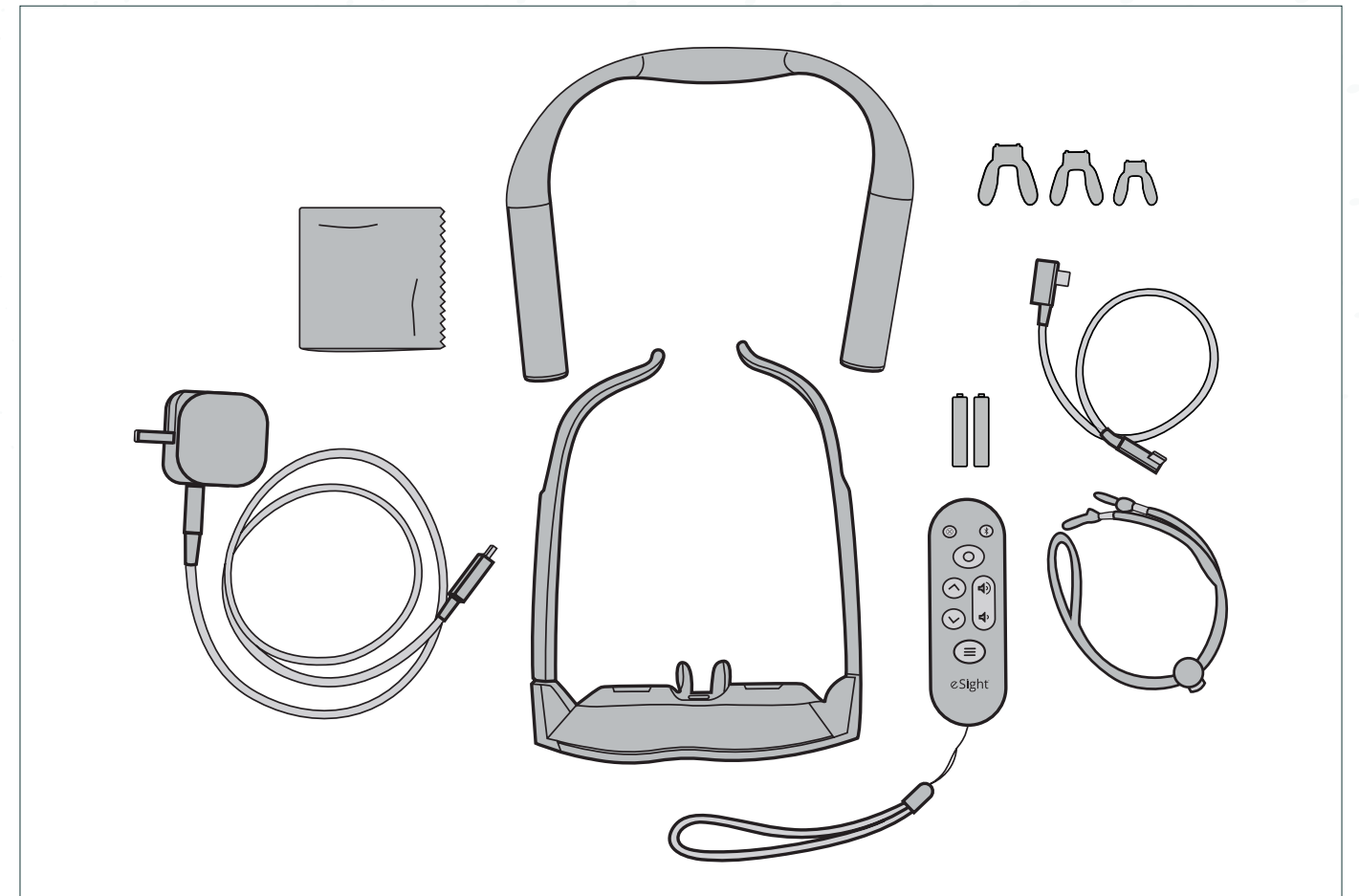

Wearing eSight Go

Connecting the Neck Battery Pack to the Device

1. Connect the shorter USB cable into the port on your neck battery pack. You'll find this under the outline marked on the pack.
2. Now, take the other end of the cable and click it into the port on the left side of your eSight glasses, just above where you feel the raised battery symbol.
3. Your eSight glasses will power up on their own. Keep an eye on the light indicators – when they're on, you're all set to see the world with eSight.

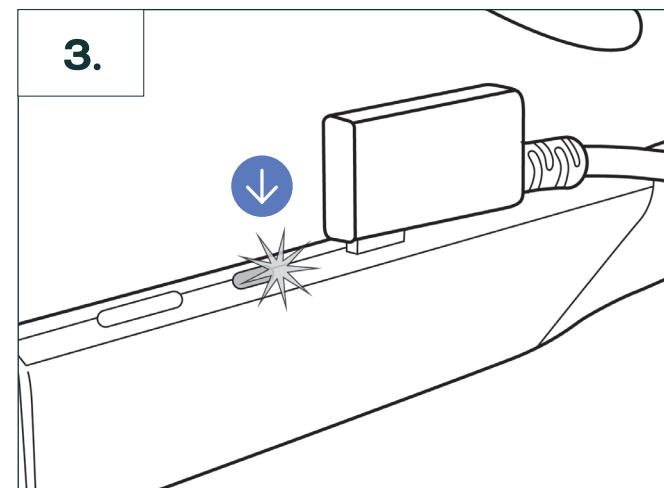
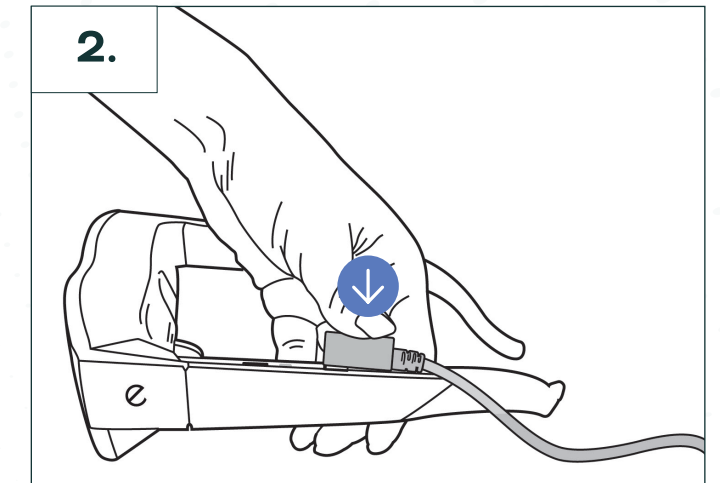
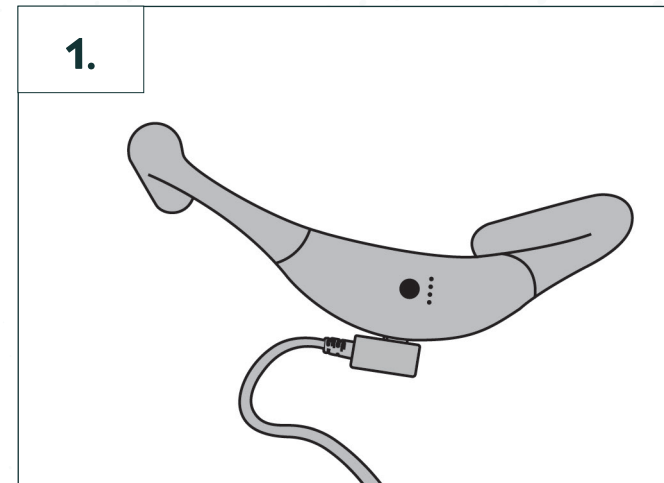

Positioning the Neck Battery Pack

1. Place the neck battery pack around your neck with the USB port at the bottom.
2. Hold the sides of the glasses, gently spread them, and put them on.
3. Take the cable and simply guide it from your glasses to the neck pack.
4. Adjust your eSight until it feels just right – for an enjoyable viewing experience every time.

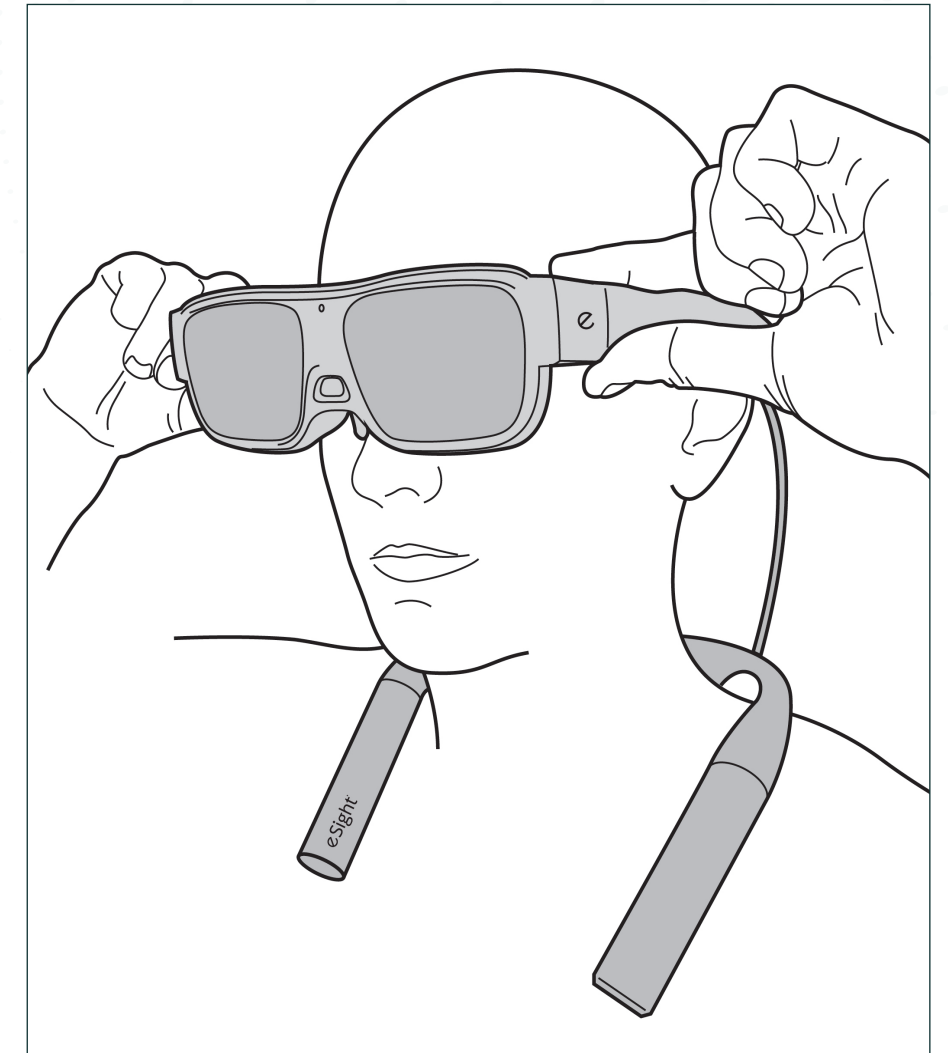

Customizing the Fit

1. Turn on your eSight Go. Close one eye, then the other, adjusting the glasses until you can see the entire display. If any of the corners are out of sight, it might be time to try a different nose piece.
2. You've got four nose pieces to choose from – each a different height. If the screen wasn't just right in step one, switch out the nose piece.
3. Give the nose pad a little tweak here and there to fit the unique contours of your nose. It's your personal touch for the perfect fit.
4. Hook on the lanyard for an even feel. It helps distribute the weight, so you can focus on seeing life in stunning clarity without any pressure.

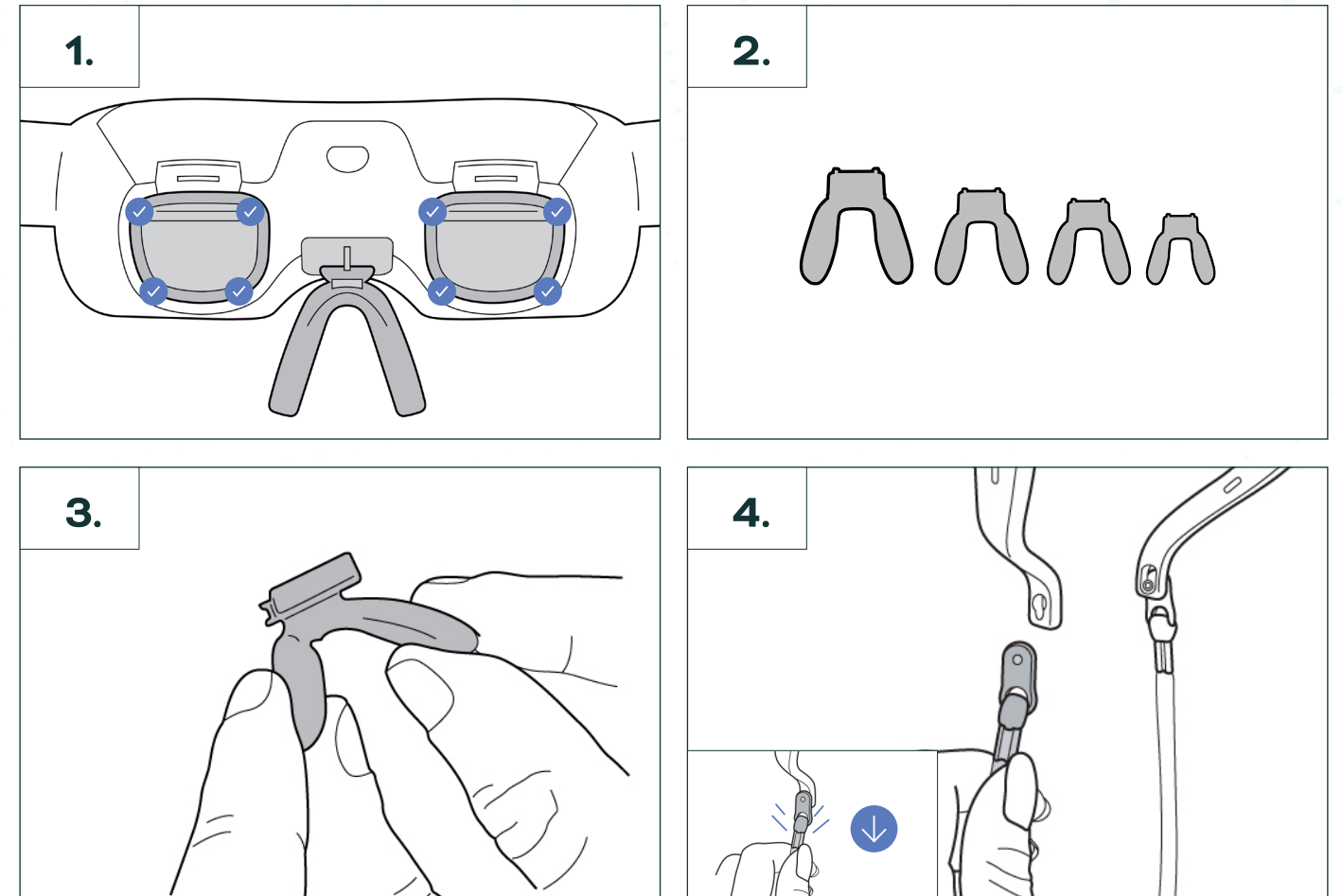

Changing Nose Pieces

- eSight Go is equipped with a set of four nose pieces, all unique in size. If the display doesn't quite fit your field of vision, or if you feel any discomfort, it might be time for a quick switch.
- Firmly hold the nose piece that's currently on your eSight Go and ease it out towards you. It should pop out with a simple, careful tug.
- Look at the different nose pieces and pick one that looks like a better fit. Push it into the slot on your eSight Go, pressing gently until it's snug.

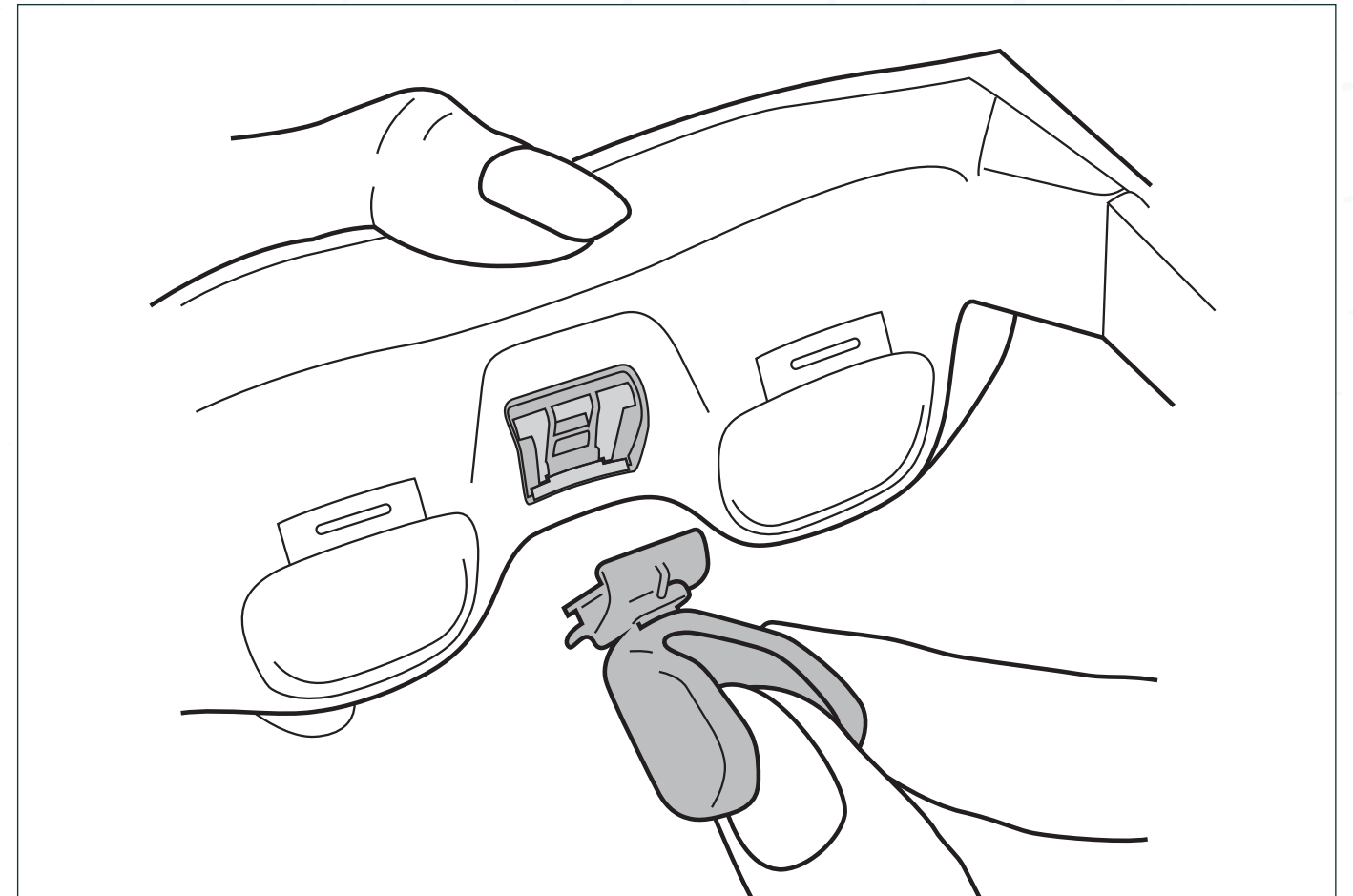

Installing Prescription Lenses

eSight Go can be used with prescription lenses.

1. Getting Ready:

- Set up a clean, well-lit space.
- Know your eSight Go: Identify the lens release tabs and holders.
- Gather your eSight Go glasses, your prescription lenses, and a microfiber cloth.

2. Removing Lenses:

- Find the tab just above each lens.
- Gently press it upwards to unlock the lens.
- Tilt your eSight Go to let the lens slide out into your hand. Touch the lens edges only to keep it smudge-free.

3. Installing Prescription Lenses:

- Check your prescription lenses for cleanliness and clarity, holding them by the edges.
- Tilt the eSight Go so the lens holders are facing up.
- Align and gently place the lens into the holder, starting from the bottom groove.
- Press the tab above the lens to lock it securely into place. Make sure it's snugly fitted at both the top and bottom.

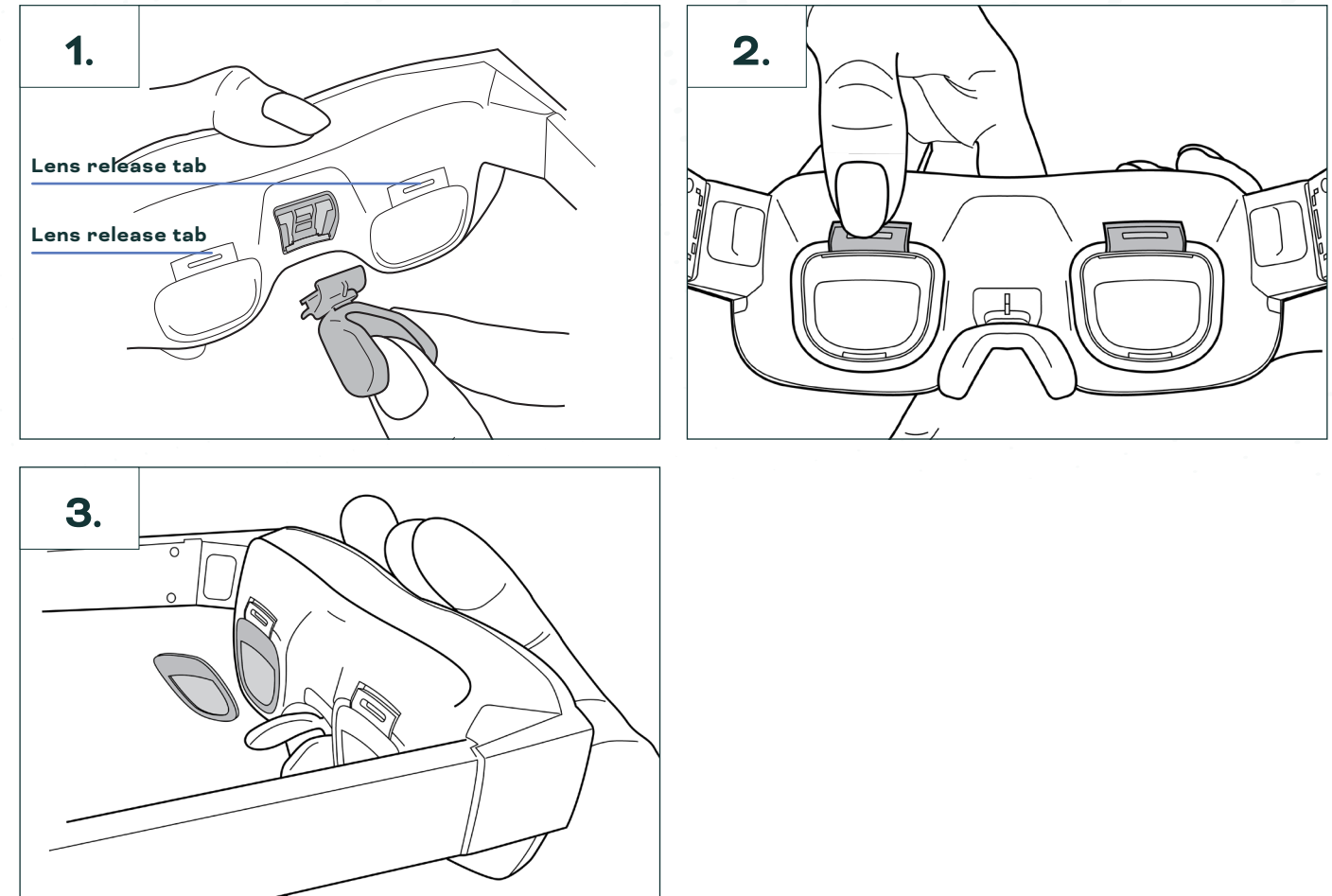

It's important to place each lens in the correct location (left or right). Lenses are provided in separate bags marked "R" for right and "L" for left.

Powering eSight Go

Neck Battery Pack (Mobile Use)

For mobility, power eSight Go using the neck battery pack with rechargeable battery.

Powering eSight Go

- Simply press the power button on the neck battery pack first.
- Then, within 20 seconds, press the power button on your eSight glasses to bring them to life.

Power Off

- A long press on the power button of your eSight glasses starts the shutdown process.
- You'll see an option to "Power Off" on the glasses
 - select it to confirm.

Sleep Mode

- To enter Sleep Mode, just tap the power button on your glasses or disconnect the cable.
- Wake them up with another tap on the power button whenever you're ready.

AC Power (Stationary Use)

For longer sessions, bypass the neck battery pack and connect the 6-foot cable from the wall adapter directly to your eSight glasses.

| Power States | Power Indicator LED |
|--------------|---|
| Power off | LED is off |
| Boot Up | LED is solid white |
| Device Ready | LED is pulsating blue. If eSharing is active, LED is solid red. |
| Sleep | LED is off |
| Error | LED is flashing red |
| Shutdown | LED is solid orange |

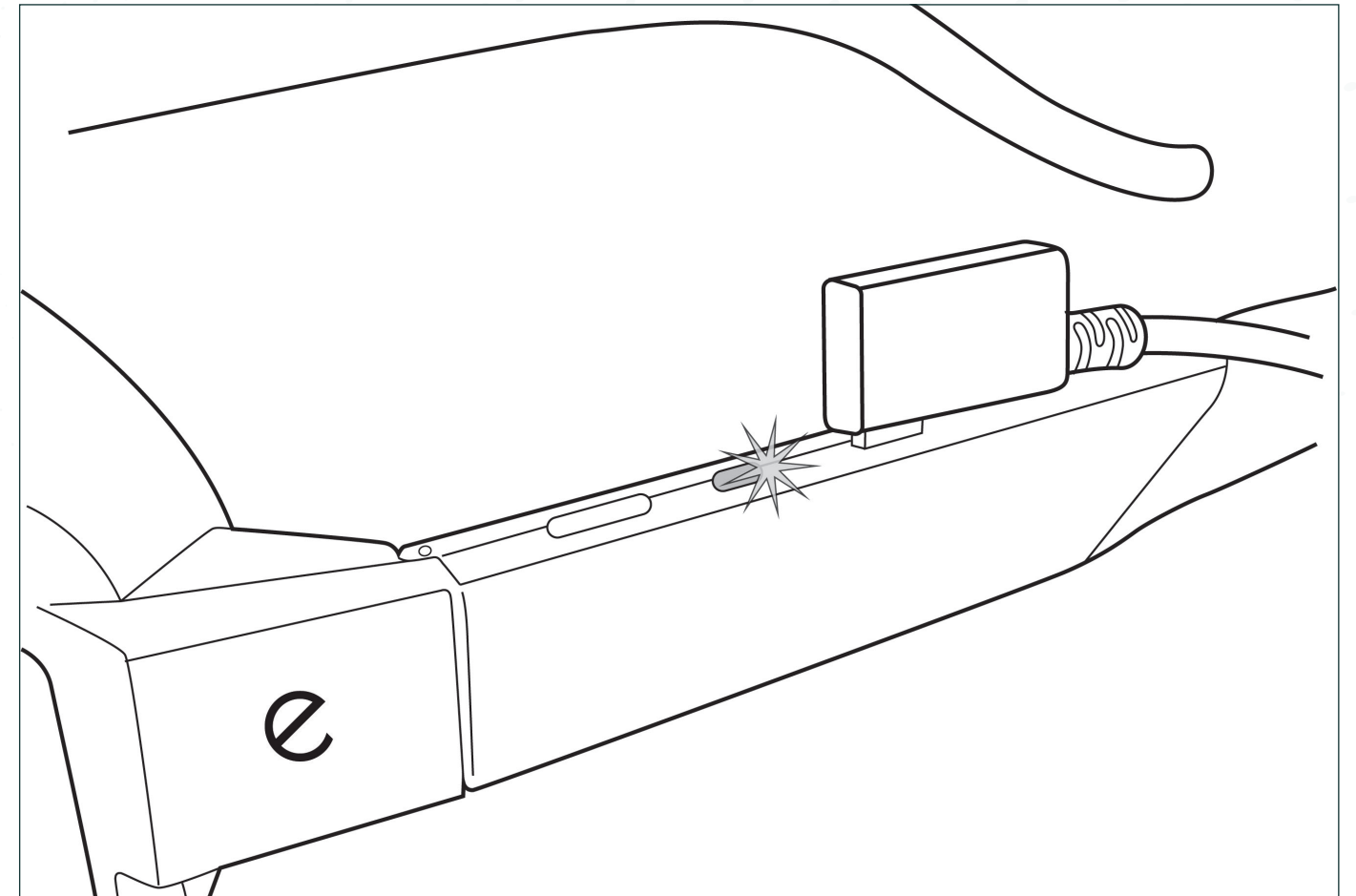







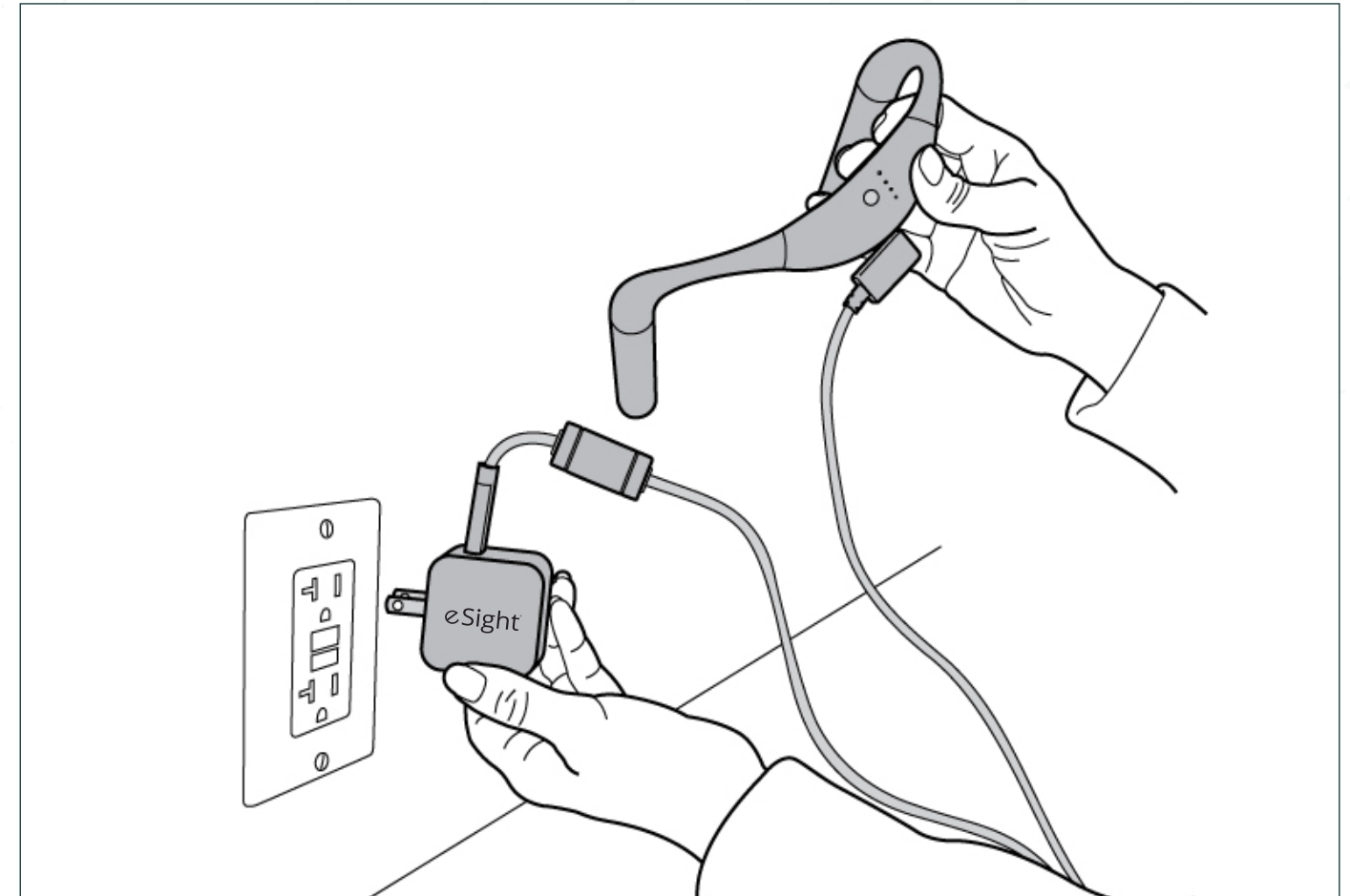



Charging the Neck Battery Pack

Charging Process

- 1.** Take the 6-foot USB cable that came with your eSight Go. Connect one end of the cable to the neck battery pack.
- 2.** Attach the other end of the cable to the AC adapter. Now, plug the adapter into a nearby power outlet to begin charging.
- 3.** Curious about the battery level? Press the button on the neck battery pack. The LED lights will illuminate, showing you how much charge is left.



| LED Indicators During Charging | Status Light | Charge Level |
|--|---|--------------|
| 1 LED flashing green |  | <25% |
| 1 LED solid green and 1 LED flash green |  | 25% - 50% |
| 2 LEDs solid green and 1 LED flash green |  | 50% - 75% |
| 3 LEDs solid green and 1 LED flash green |  | 75% - 100% |
| 4 LEDs solid green |  | 100% |
| LED Indicators During Use | | |
| 0 LED green |  | <25% |
| 1 LED flashing green |  | 25% - 50% |
| 1 LED solid green |  | 50% - 75% |
| 2 LEDs solid green |  | 75% - 100% |
| 3 LEDs solid green |  | 100% |
| 4 LEDs solid green |  | |

eSight Go Remote

Powering Up the Remote:

- Insert Batteries: Begin by inserting the 2x AAA batteries into your eSight Go remote. This will power it up and get it ready for pairing with your headset.

Pairing Your Remote with eSight Go:

- Remote in Pairing Mode: To start pairing, press and hold the Bluetooth button on the remote for three seconds. Watch for the red light to start flashing, indicating that the remote is in pairing mode and looking for your headset.

Preparing Your eSight Go for Pairing:

- Now, let's get your eSight Go ready. If the headset isn't already in pairing mode (indicated by a blue flashing light), you can activate it by first putting the headset into sleep mode and then waking it up. Do this by pressing the power button on your glasses. This step is key to initiating the pairing mode.

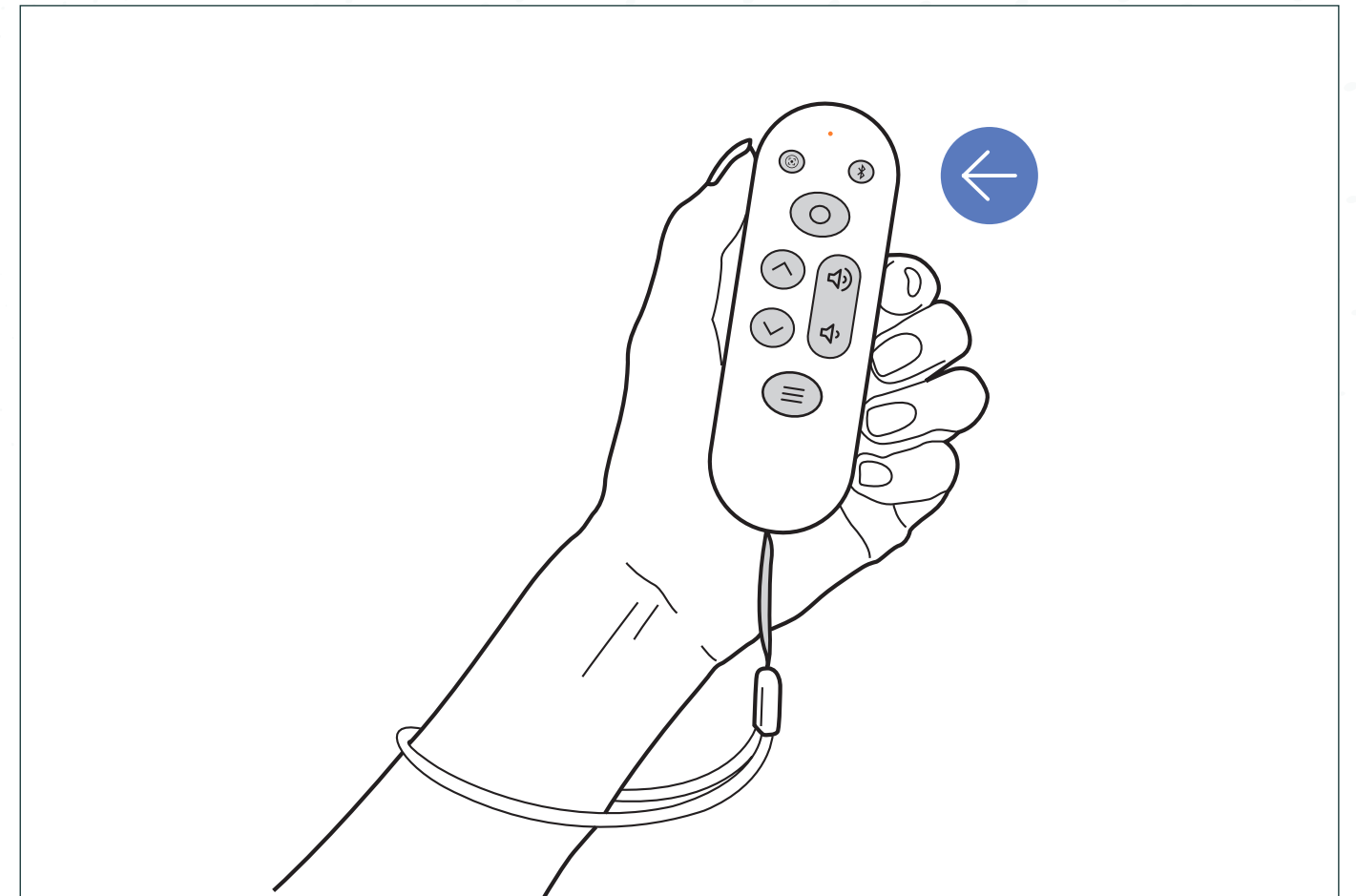

Spot Zoom Button

- The device resets to zoom level 1 when this button is held. When released, it will jump back to the previous zoom setting.

Volume Buttons

- Volume up or down

Bluetooth Button (enter pairing mode)

- Pair the remote with the device
- Hold for 3 seconds when near eSight Go
 - Ensure that eSight Go is in pairing mode (flashing blue LED)

Menu Button

- Open/Close the menu
- Long press (>2 seconds) to enter/exit freeze frame view

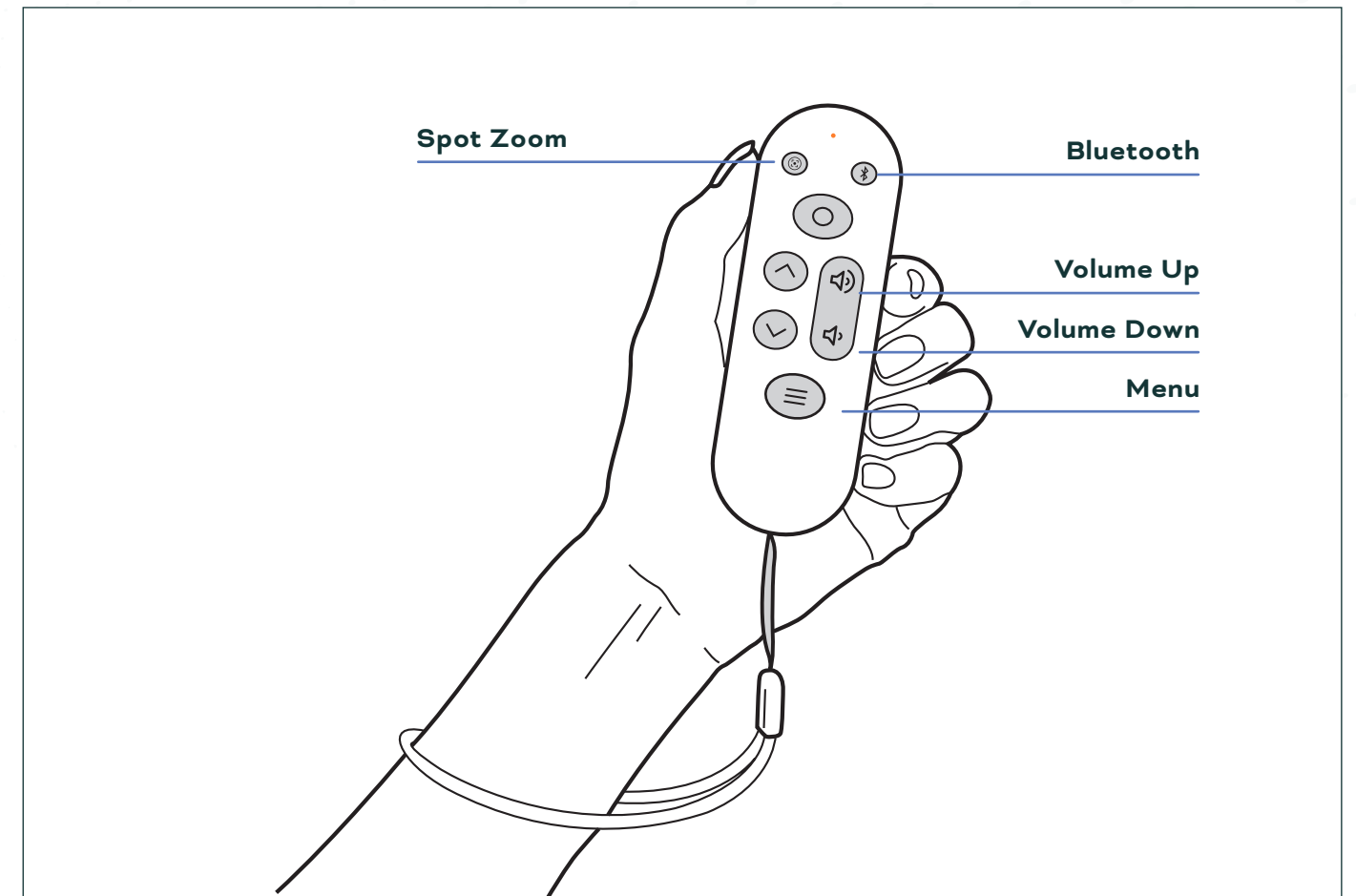

Mode Button

- Select the current option
- Change the mode in live view and freeze frame view
- Long press (>2s) to reset the view in live view and freeze frame view

Sleep Mode

- The remote will automatically go to sleep if no button is pressed for 10 minutes
- To wake the remote, press any button
 - Remote LED will flash green to show that it reconnected

Navigation Buttons

- Navigate up or down in the menu
- Increase or decrease zoom, contrast, filters, volume, or tilt when in live view

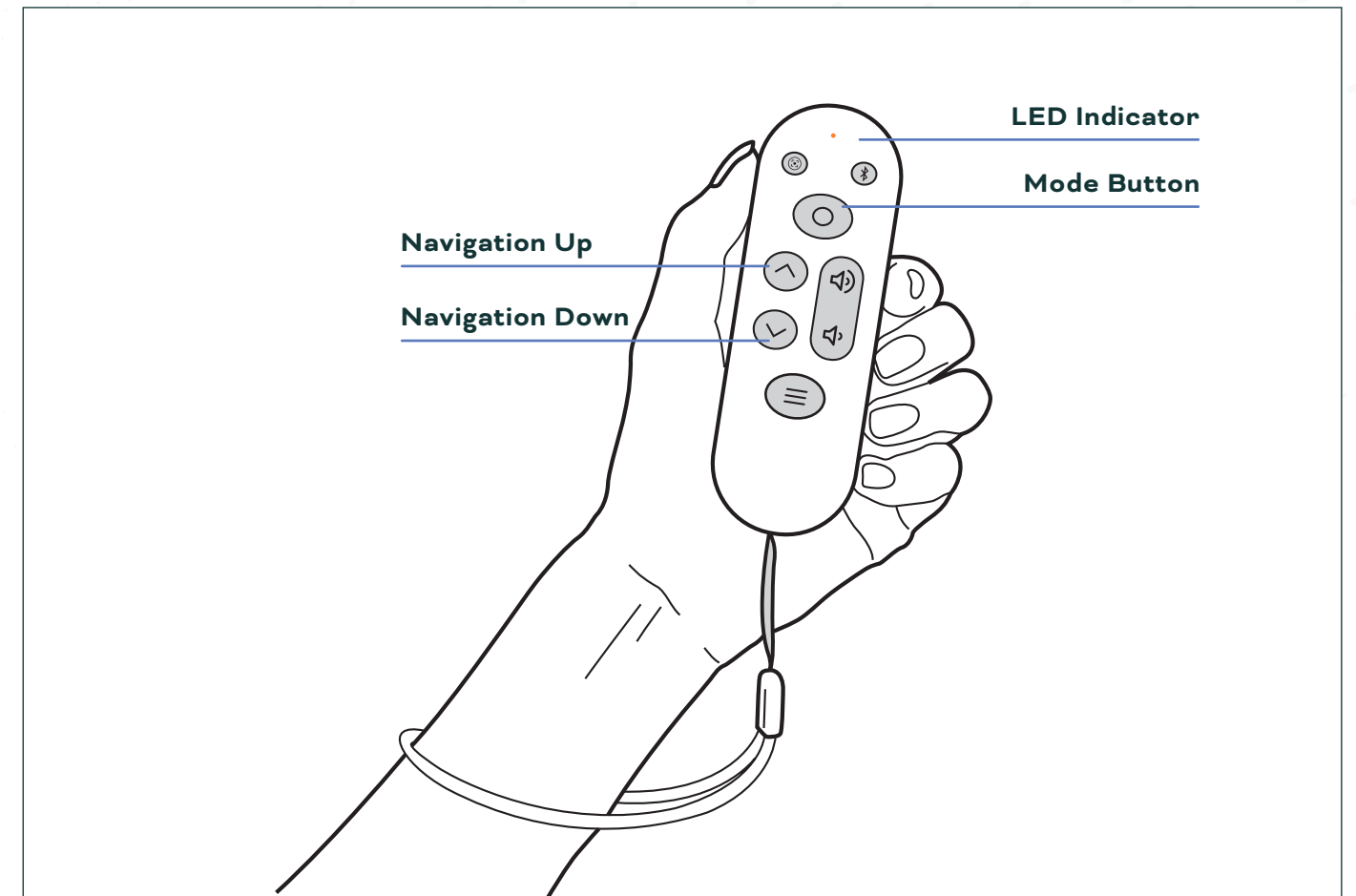

Additional Information

eSight Device

- Power button
- Control buttons
- LED light
- USB-C port

Neck Battery Pack

- USB-C port
- Power button
- Battery status lights

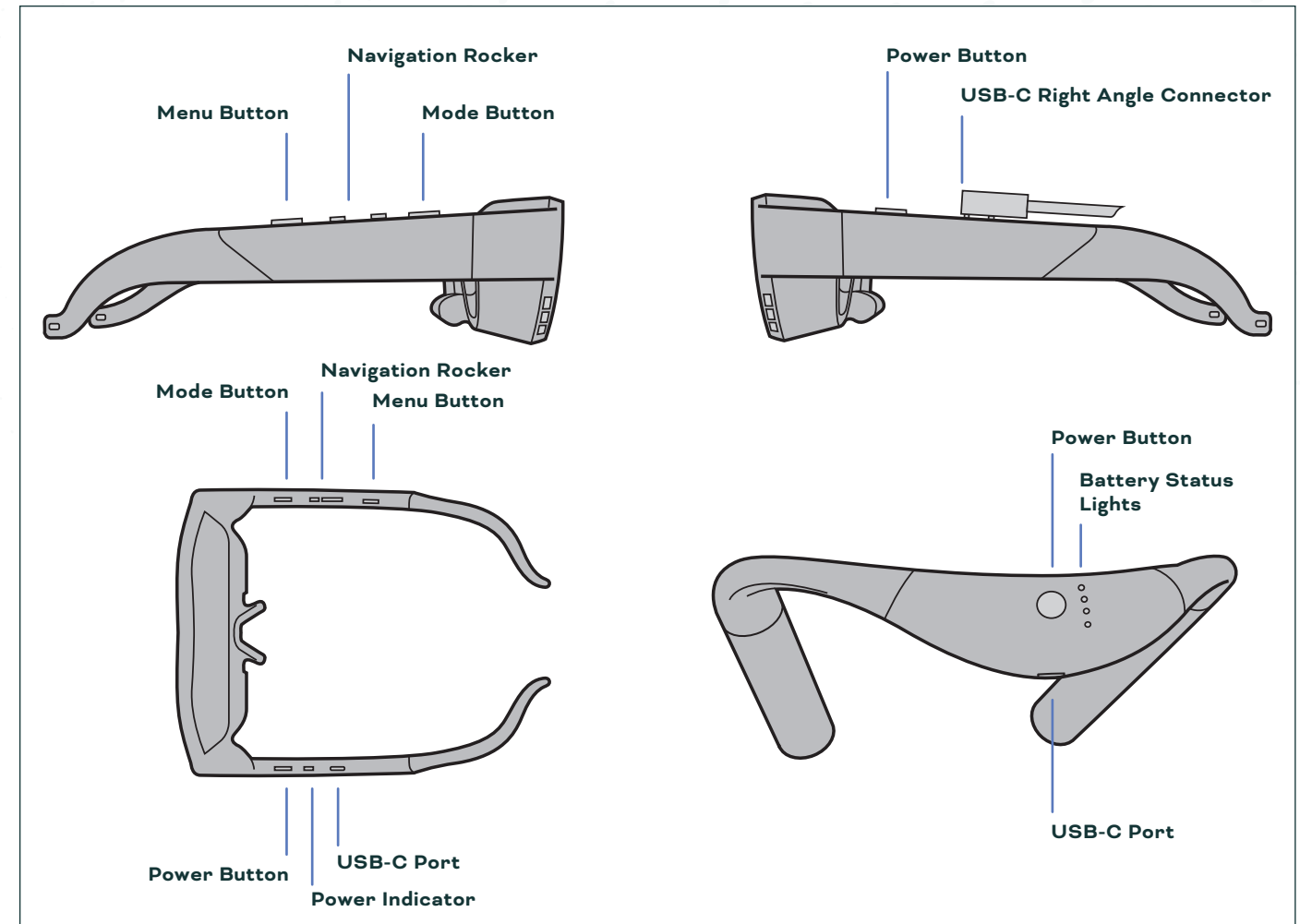

Mode Button Functions

- Zoom (Mode 1): Focus on objects at different distances
- Contrast (Mode 2): Fine-tune contrast for improved clarity
- Filters (Mode 3): Choose from various color filters for optimal viewing
- Volume (Mode 4): Adjust audio volume levels
- Tilt (Mode 5): Adjust viewing angle for comfort
- Usage:
 - Short Press (<2s): Select the highlighted option in any mode
 - Long Press (>2s): Reset the view in live or freeze frame modes

Menu Button Operations

- Short Press (<2s): Opens/closes the menu or returns to the previous menu
- Long Press (>2s): Engages/closes the freeze frame view

Power Button Functions

- Short Press (<2s): Powers on the device or activates sleep mode
- Press and hold power button for 5 seconds. Confirm shutdown by selecting "Power Off" on device.
- Long Press (>10s): Executes a forced shutdown

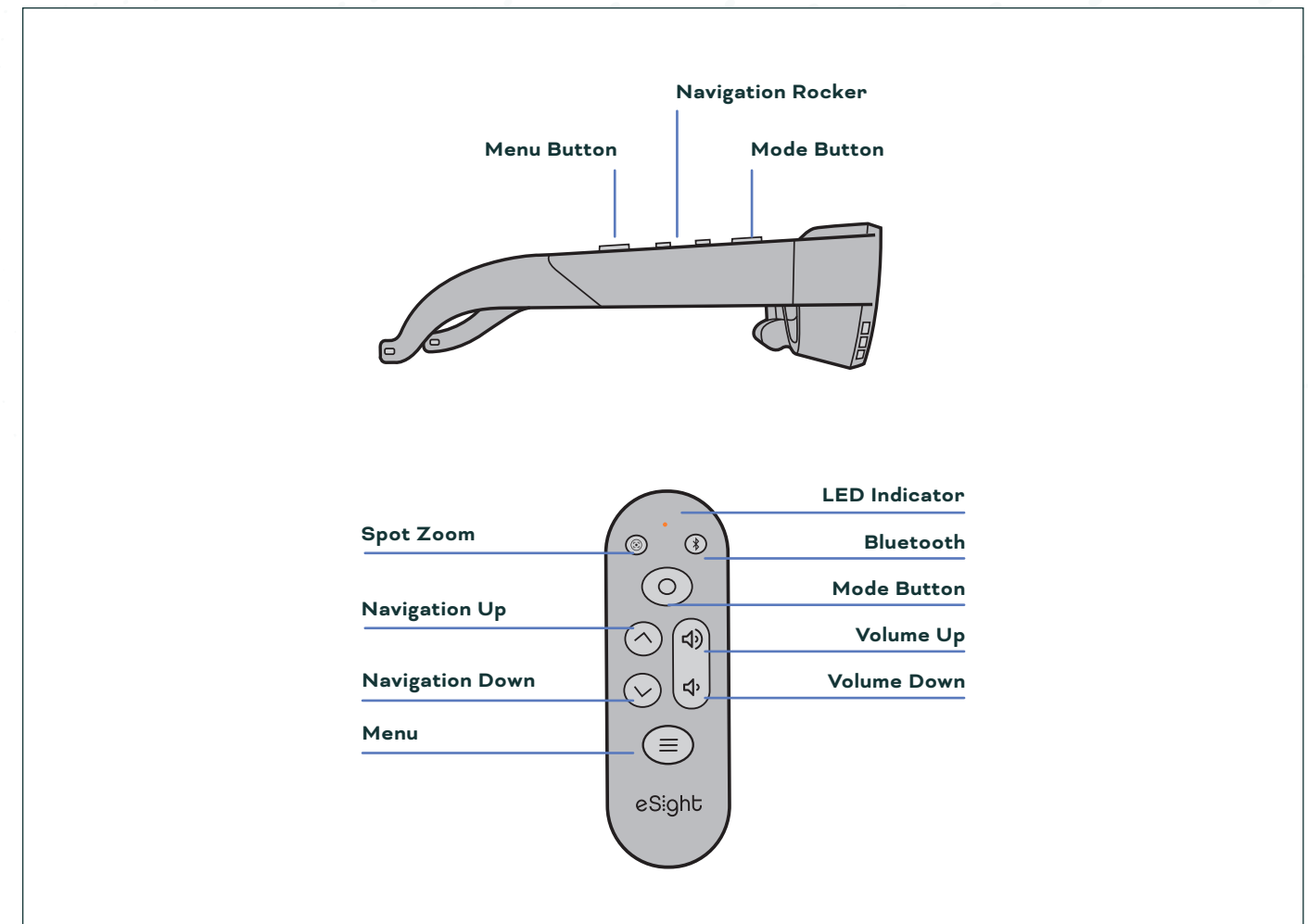

Brightness

- Auto-brightness allows the device to adjust to ambient lighting conditions
- Manual brightness allows you to select a specific brightness level

Appearance

- Choose from a list of different color settings to help read the menu text

Flicker Control

- Change the flicker setting depending on the country the device is in

Select Screen

- Choose to disable one of the displays

Language

- Switch between different languages

Connectivity

- Bluetooth devices can be erased or disconnected through this menu
- Wi-Fi: Manage networks and add a new network with the QR Scanner
 - QR Scanner will scan the QR Code generated by the eSight mobile app

Support

- About: This menu contains information about the eSight device
- Support: Check for a software update

Reset to Default Settings

- Restore all the user selectable options back to their default setting

Auto-focus

- Seamlessly focus on different objects at different ranges

Over the Air Updates - Wireless Software Updates

- Updates will begin to download when eSight Go is connected to Wi-Fi if there is one available
- Updates can also be found in the Support Menu

eShare - Wirelessly Share the Video Feed with Support

- eShare can be used by both the mobile app and the web app
- A request must be accepted on the device
- There is a red border that surrounds the image on the device to let you know you are eSharing
- To disconnect the eShare session, there is an option in the menu that will allow you to end the session

Image Stabilization

- Reduce bouncy/jittery camera movements

Text Narration

- The device will read the on-screen text to you

Device Cleaning and Care

Surface Cleaning:

- Use the provided microfiber cloth to gently clean the surfaces

Camera and Sensors:

- Utilize compressed air to clear any debris from the camera apparatus and sensors

Lens Maintenance:

- Wipe the lenses gently from the outer edge towards the center

Important Safety Tips:

- **Avoid Moisture:** Keep the device dry; do not immerse in liquids
- **Chemical Exposure:** Avoid contact with ethanol-based products such as bug sprays, which may damage the device
- **Proper Storage:** When not in use, store eSight Go in its case to prevent damage
- **Avoid Foreign Substances:** Do not use household cleaning products on device components
- **Dry Before Use:** Ensure the device is completely dry before charging or turning it on

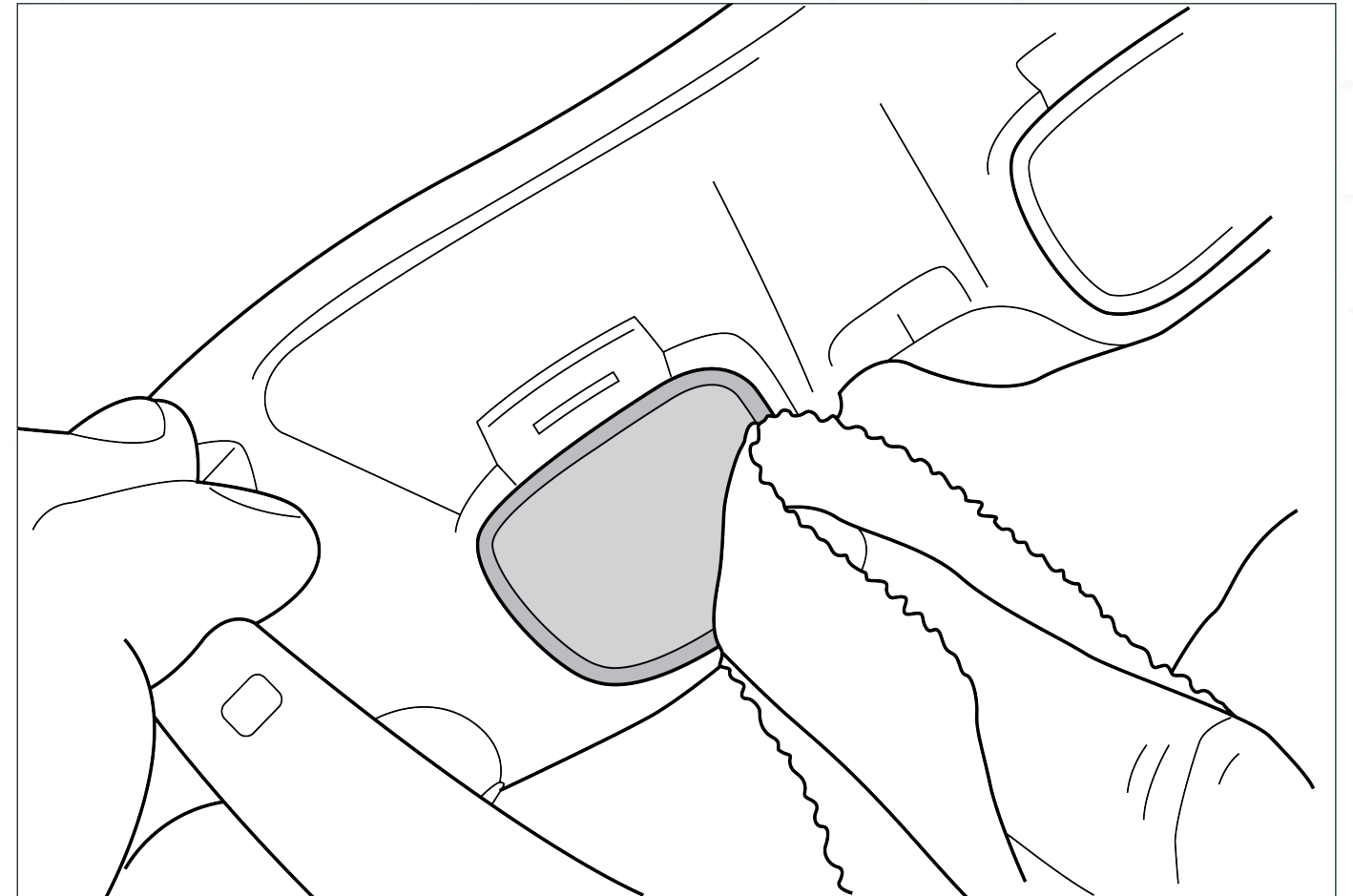

Carrying Case

To ensure safe keeping of your eSight Go when not in use, place device and components into appropriate carrying case slots.

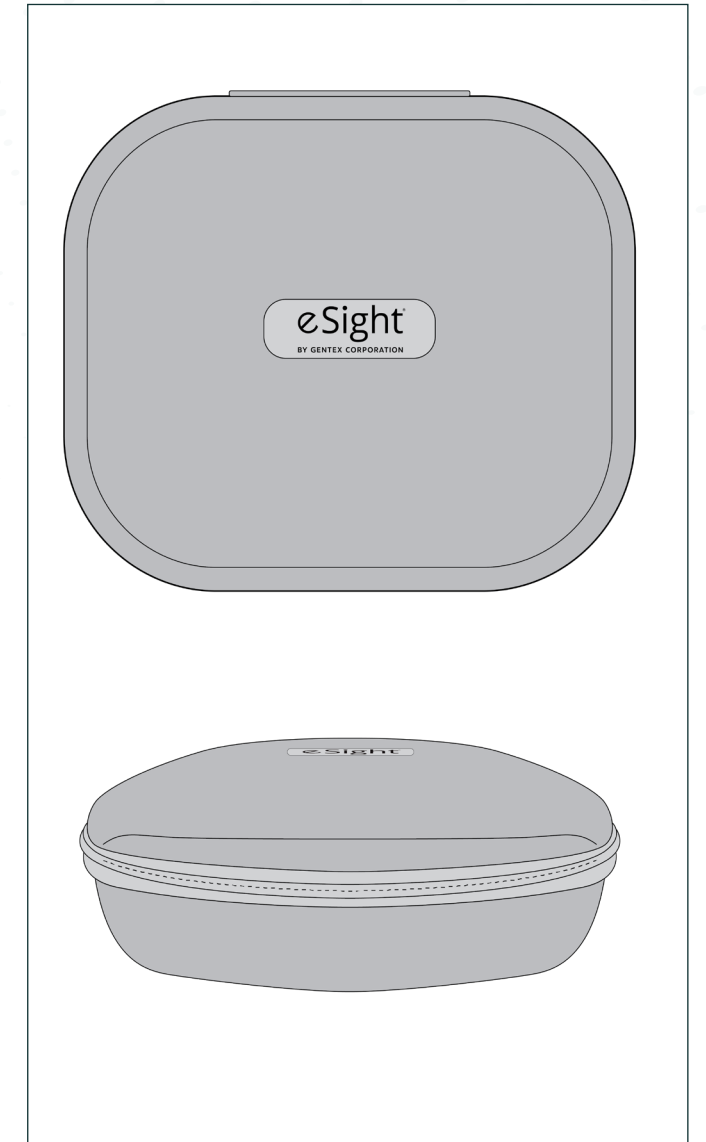
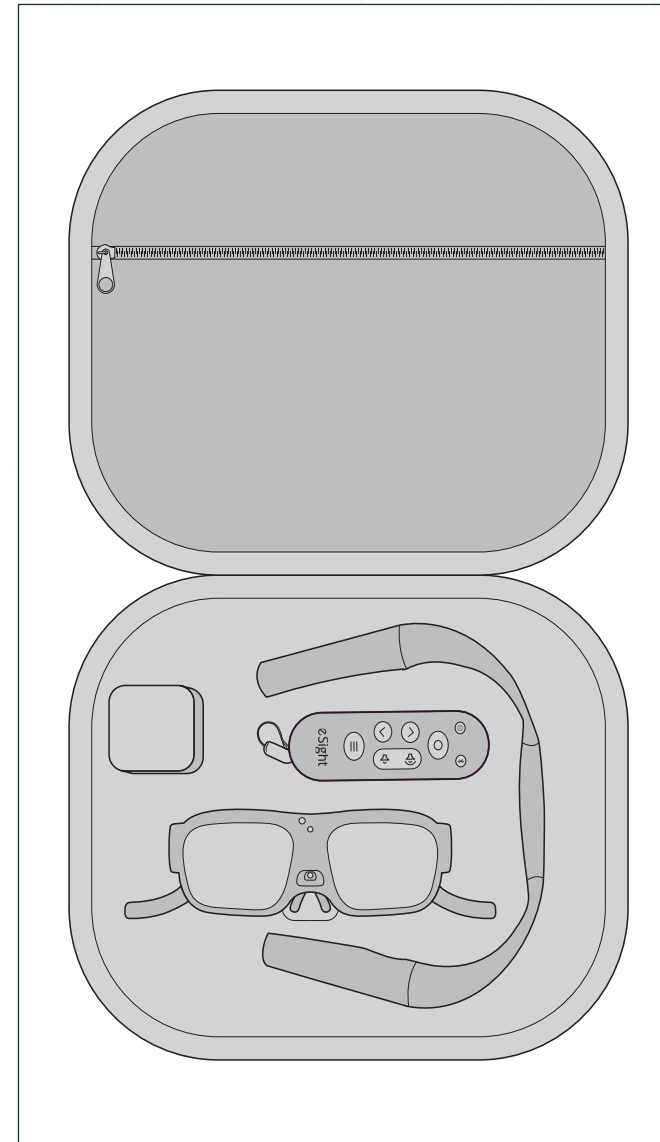

Instructions for Wi-Fi Setup:

1. **QR Code Generation**
 - Visit www.esighteyewear.com/esight-go-support or use the eSight mobile app to generate a QR code for Wi-Fi connection
2. **Access Wi-Fi Settings**
 - On your eSight Go, navigate to Settings > Connectivity to open Wi-Fi settings
3. **QR Code Scanning**
 - Scan the generated QR code using the eSight Go device to connect to the Wi-Fi network.

**Important Compatibility Note:**

Network Frequency Limitation: eSight Go is compatible only with 2.4 GHz Wi-Fi networks. It does not support 5 GHz Wi-Fi networks. Please ensure your network is compatible before attempting to connect.

Display

Field of view diagonal 45 degrees

Power

Run Time - 180 minutes

- Battery
- Integrated lithium-ion battery in device
 - Rechargeable lithium-ion battery in neck battery pack
 - Maximum charge voltage and current: 5.0V & 3.0A
 - Type-C USB Cable with USB AC wall adapter
 - Recharge from a wall outlet
-

Connections

USB

Bluetooth

- Wi-Fi
- 2.4 GHz
 - Allows connection for device updates and remote support
-

Sound

| | | |
|-----------------|---|-----------------------------|
| Device Speakers | - | For user interface feedback |
|-----------------|---|-----------------------------|

Operating Environment

| | | |
|-----------------------------|---|-------------------------------|
| Operating Temperature Range | - | 0°C to 38°C (32°F to 100.4°F) |
|-----------------------------|---|-------------------------------|

| | | |
|---------------------------|---|-------------------------------|
| Storage Temperature Range | - | -20°C to 45°C (-4°F to 113°F) |
|---------------------------|---|-------------------------------|

If the neck battery pack does not power on or shows signs of not working as expected, this may be due to exposure to cold temperatures. eSight Go is designed to withstand storage temperatures as low as -20°C (-4°F). However, prolonged exposure to such temperatures can affect battery performance.

If your eSight Go has been stored at or below freezing temperatures, please follow these steps:

1. Connect the neck battery pack to the charger using the provided cable
2. Charge the neck battery pack for at least 15-30 minutes. This brief charging period allows the battery to warm up and regain its ability to function correctly.

Customer Support (Canada and the United States)

- www.esighteyewear.com/contact
 - help@esighteyewear.com
 - 1-855-837-4448 – follow the prompts to contact your eSight Coach
 - For further support, please contact your eSight Authorized Distributor or dispensing clinic directly. They are trained to provide full support in your local language and time zone.
-

eSight Customer Support Outside North America

For international assistance, please reach out to your local eSight Authorized Distributor or dispensing clinic. They offer comprehensive support in your native language and are aligned with your local time zone.

Warranty

www.esighteyewear.com/esight-go-support

Identification

Your eSight Go serial number can be found on the right arm of your device

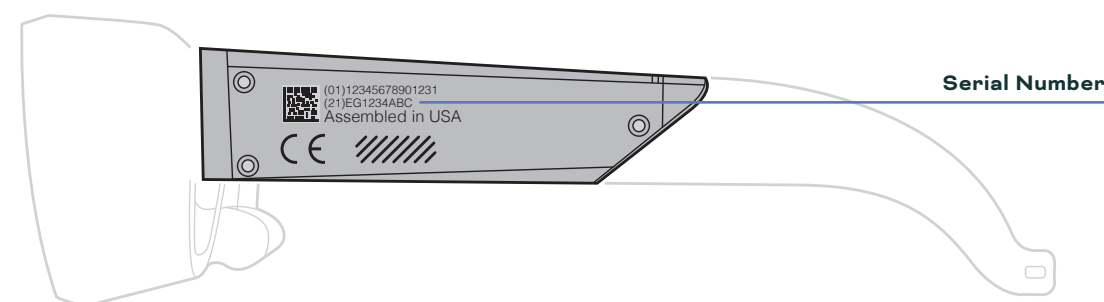

Exit Pairing Mode

- Pressing the Bluetooth button and the Volume Up button at the same time will make the remote exit pairing mode
-

Delete Bluetooth Pairing Information

- Pressing and holding the Bluetooth button and the Menu button for 3 seconds will delete all bonding information from the remote
 - The LED on the remote will rapidly flash green for 3 seconds Remote Functions eSight Go User Manual
-

Appendix

The Zoom feature significantly enhances visual experiences by providing up to 24x magnification. This feature is particularly beneficial for maximizing the use of remaining vision, making it one of the most frequently used functions on eSight Go.

How to Use Zoom:

1. **Activating Zoom Mode:**
 - Press the Mode button until the Zoom function is activated.
2. **Adjusting Magnification:**
 - Increase magnification by pressing the 'up' button, either on the remote control or directly on the glasses.
 - Decrease magnification using the 'down' button. This flexibility allows for precise control over the level of zoom, depending on the specific need.

User Experience Tips:

- **Experimentation:** Familiarize yourself with various zoom levels to understand what works best in different scenarios. Experimentation is key to leveraging the Zoom feature effectively.
- **Balancing Views:** While high magnification offers detailed views, it's essential to balance it with lower magnification for broader perspectives, especially when navigating or orienting in new environments.

Contrast adjustment helps to improve image clarity. This feature adjusts the dark and light areas of an image, making it easier to distinguish details. It's particularly beneficial for users who need to discern fine details or require a clearer separation between light and dark elements in their view.

How to Use Contrast

1. Activating Contrast Mode:

- Press the Mode button until the Contrast feature is activated.

2. Adjusting Contrast:

- Use the 'up' and 'down' buttons on the remote or the glasses to modify the contrast levels.
- Observe the changes in real-time as the system provides visual and auditory feedback, enhancing the overall user experience.

User Experience Tips:

- Experimentation: Try using different contrast levels to find what suits your vision needs best, especially when dealing with various lighting conditions or types of content.
- Balancing Contrast: It's important to find a balance in contrast settings that enhances visibility without causing visual discomfort or distorting the image quality.

Filters are designed to enhance visual comfort and ease of reading by offering various color schemes. These color schemes can be particularly helpful for individuals with specific eye conditions, providing an optimized viewing experience.

Types of Filters and Their Purposes

- **Normal (Full Color):** Ideal for general viewing and reading.
- **Black / White:** Primarily used for reading, enhancing text visibility.
- **White / Black:** A reading-friendly option, offering a high-contrast visual.
- **Blue / Yellow & Yellow / Blue:** These color combinations are beneficial for reading, offering a visually comfortable background.
- **Grayscale:** Suitable for both general viewing and reading, providing a distraction free visual environment.

Using the Filters Feature

1. Activating Filters Mode:

- Press the Mode button until Filters is enabled.

2. Selecting a Filter:

- Use the 'up' and 'down' buttons on the remote or glasses to navigate through different filter options.

User Experience Tips:

- **Personalization:** Experiment with different filters to discover what works best for your specific needs and preferences.
- **Adaptability:** Different environments and tasks may require different filters. Be flexible in switching between them for the best experience.

The Tilt feature is designed to enhance ergonomic comfort and reduce neck strain. It allows you to adjust the vertical angle of the display, making it easier to view without tilting your head for extended periods. This feature is particularly useful for activities like reading or observing objects at different heights.

How to Use the Tilt Feature

1. Activating Tilt Mode:

- Press the Mode button until the Tilt mode is activated.

2. Adjusting the Display Angle:

- Once in Tilt mode, use the 'up' button on the remote control or the buttons on the glasses to adjust the display angle upward.
- To tilt the display downward, use the corresponding 'down' button.

User Experience Tips:

- **Ergonomic Adjustment:** Use the Tilt feature to find the most comfortable viewing angle, reducing the need for physical adjustments and preventing neck strain.
- **Task-Specific Settings:** Different activities may require different tilt angles. For example, reading might need a different tilt compared to general viewing.

Freeze Frame enables you to pause the camera image at any moment. This function is especially beneficial for managing image bounce and simplifying tasks like reading at higher magnification levels.

How to Use Freeze Frame

1. Activating Freeze Frame:

- To enable Freeze Frame, press and hold the Menu button until the feature is activated.
- You will receive an audio confirmation indicating that Freeze Frame is now active.

2. Utilizing Freeze Frame:

- While the image is frozen, you can still adjust zoom, contrast, and filters to enhance the static image.
- This is particularly useful for reading or observing details at high magnification, where even slight head movements can cause image bounce.

3. Deactivating Freeze Frame:

- To return to live view, press and hold the Menu button again.
- The system will confirm the deactivation of Freeze Frame mode.

User Experience Tips:

- **Stability for Clarity:** Ensure a steady gaze when activating Freeze Frame for a sharp image.
- **Task Adaptability:** Use Freeze Frame to pause the image for detailed examination, especially in tasks requiring focused attention on specific details.

The Finder enhances your ability to quickly orient yourself in various viewing situations. This feature is particularly useful when using high magnification settings or when needing to swiftly change focus between multiple points of interest.

How to Use Finder

1. Accessing Finder:

- The Finder feature is exclusively available via the remote control.
- To activate Finder, press the dedicated Finder button on the remote.

2. Functionality of Finder:

- When activated, Finder temporarily removes magnification, allowing you to view your surroundings in a standard setting.
- This is invaluable for tasks like scanning between actors in a play or adjusting focus when a new element enters your field of view.

3. Returning to Previous Settings:

- Releasing the Finder button automatically reverts the view back to the preset magnification level, ensuring a seamless transition between different focus points.

User Experience Tips:

- **Rapid Orientation:** Ensure a steady gaze when activating Freeze Frame for a sharp image.
- **Enhancing Viewing Experience:** Finder is a powerful tool for situations like attending live performances or navigating busy areas, where maintaining spatial awareness is crucial.

The Reset feature enables you to swiftly revert to default settings within any active mode. This function is invaluable for users who frequently adjust settings and require a quick way to return to baseline parameters.

How to Use Reset View

1. Activating Reset View:

- Press and hold the Mode button. This action triggers the return of eSight to its default settings.

2. Functionality of Reset View:

- The Reset button impacts various features including zoom and contrast, resetting any adjustments made while in a specific mode.

User Experience Tips:

- **Situational Application:** Use Reset View when you need to start over with your adjustments.
- **Frequent Adjustments:** For users who often experiment with settings, mastering the use of Reset View can significantly enhance your experience by providing a quick way to revert to a default state.

eSight[®]
BY GENTEX CORPORATION